

VOLKSWAGEN

AKTIENGESELLSCHAFT



Operating manual

High-voltage test adapter VAS 6558/22



Revision	Date	Reason
V00	17.08.2020	First edition

Legal notice

Manufacturer

CAR-connect GmbH
Am Egelingsberg 8
38542 Leiferde, Germany
Phone: +49 (0) 5373 92197-0
Fax: +49 (0) 5373 92197-88

info@car-connect.cc
www.car-connect.cc

Reproduction

Reproduction or reprinting, whether in whole or in part, always requires the written permission of the manufacturer.

Copyright

TRANSLATION OF THE ORIGINAL OPERATING MANUAL

All rights reserved.

All text, images and graphics are subject to copyright and other intellectual property laws.

Copyright 2020 CAR-connect GmbH.

Image sources

Symbols for warnings, prohibitions, mandatory actions and standards are taken from publicly accessible sources, such as the Internet. CAD product images and product photos are provided by the manufacturer. Images showing the product in use are provided with a reference to the source.

Contents

LEGAL NOTICE	2
CONTENTS	3
INTRODUCTION	4
Preliminary information	4
Validity of the declaration of conformity	4
Manufacturer specifications	4
SAFETY	5
Warning levels	5
Important safety instructions	6
Intended use	7
Requirements for the target group	7
PRODUCT DESCRIPTION	8
Scope of delivery	8
Design	8
Symbols and connections	9
Wiring diagram	11
Technical data	12
OPERATION	13
Startup	13
Cleaning	14
Disposal	14
Maintenance	14
HELP	15
Warranty	15
Customer service	15

Preliminary information



CCS2 (“Combined Charging System”) is the international charging standard for a combined charging system with a type 2 charging coupling.

Read through this operating manual carefully before using the product.

The product is delivered with a USB stick containing the operating manual in various languages. You can find the current version and additional languages on our homepage.

The operating manual is an essential part of the product and must be kept together with the product. If you sell or transfer ownership of the product, the operating manual must be handed over to the new operator.

In addition to this operating manual, you must observe all relevant regulations for diagnostics or fault finding of intrinsically safe high-voltage systems in road vehicles. This includes but is not limited to: instructions for the vehicle manufacturer’s diagnostics systems, company-specific safety requirements and the state of the art for working with high-voltage systems.

Validity of the declaration of conformity

The declaration of conformity applies to the product described in the operating manual. Any changes, modifications or extensions shall void the declaration of conformity and the risk assessment.

Manufacturer specifications

CAR-connect GmbH



Since its founding, our company has focused on groundbreaking solutions for electromobility. CAR-connect develops and produces custom solutions for the automotive industry, repair shops and special vehicle fleets.

Our core business is developing and producing innovative high-voltage charging technology for electric vehicles. Our portfolio also includes measurement and diagnostic technology for the entire vehicle and battery analysis equipment.

With extensive experience in software and hardware development, CAR-connect is your dependable partner at every production stage, from prototyping to series production.

CAR-connect GmbH – Experience, Expertise and Innovation – MADE IN GERMANY

This safety chapter provides information about the following:

- The warning levels contained in this operating manual
- Important safety instructions for the product
- Intended use of the product
- Requirements for the target group

This operating manual is only valid for the following product:

Item number	22101589
Designation	High-voltage test adapter VAS 6558/22

Warning levels

This chapter provides information about the warning levels used in this operating manual.

DANGER

Failure to observe the safety instructions **WILL** result in death or serious injury!

WARNING

Failure to observe with the safety instructions **CAN** result in death or serious injury!

CAUTION

Failure to observe the safety instructions **CAN** result in minor physical injury!

Important safety instructions

This chapter contains the safety instructions that must be observed when handling the product.



DANGER

Danger of fatal electric shock!

The electrical voltage in other systems is lethal and will cause death by electric shock!

- Do not use the product for measurements on utility power circuits!
- Never attempt to power other devices with the product!



WARNING

Danger of fatal electric shock!

The electrical voltage in high-voltage systems is lethal and can cause death by electric shock!

Liquids, condensation and high humidity can cause short circuits!

- Do not let the product come into contact with liquids!
- Use the product only in dry and enclosed spaces!



WARNING

Danger of fatal electric shock!

The electrical voltage in the product is dangerous and can cause serious injury or death from electric shock!

Defective and damaged products cannot guarantee protection against electrical voltage!

- Do not let the product come into contact with chemicals!
- Replace a defective or damaged product immediately!
- Never attempt to repair or tamper with the product!

Intended use

The high-voltage measurement adapter is used to perform safety-relevant tests and measurements on the high-voltage vehicle electrical system.

Use the high-voltage measurement adapter only on the charging socket specified by the vehicle manufacturer in the guided fault finding!

The high-voltage measurement adapter is only suitable for safety-relevant tests on the high-voltage vehicle electrical system.

The product is suitable for the following measurements:

- Insulation resistance measurement
- Continuity measurement

In this operating manual, vehicle manufacturers are exclusively defined as vehicle manufacturers in the Volkswagen Group.

The high-voltage measurement adapter is only compatible with vehicles for the Chinese market.

Any use beyond what is listed here is prohibited.

Requirements for the target group

Only qualified personnel may work with this product!

In this operating manual, qualified personnel is defined as personnel meeting the requirements prescribed by the vehicle manufacturer for the Guided Fault Finding in the respective country of operation.

Scope of delivery

Immediately check the condition of the product and the completeness of the delivery. If anything is missing or defective, please contact the manufacturer immediately.

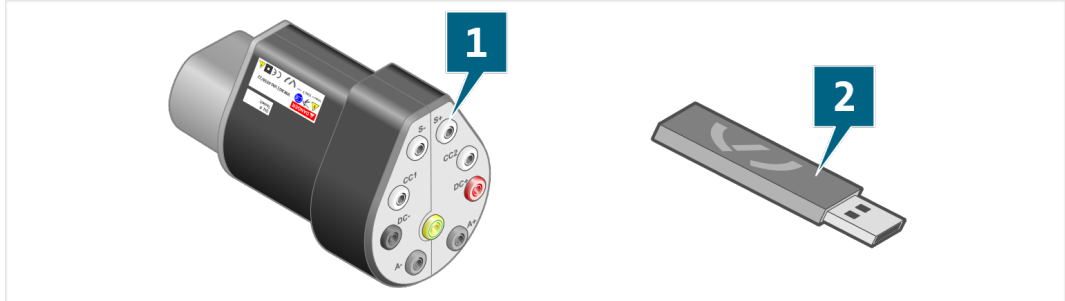

- (1) High-voltage measurement adapter
- (2) USB stick with operating manual

Design









Product design:





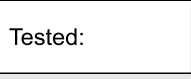



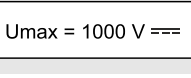

- (1) Plug
- (2) Test sockets (see wiring diagram)

Symbols and connections

The following symbols are shown on the product:

Symbol	Meaning
	General warning symbols
	Electrical hazard! Read the operating manual!
	Serial number of the product
	Manufacturer part number
	Date of manufacturer's test
	Disposal instruction
	Protection class II
	Mark of conformity
	Vehicle manufacturer's certification mark
	Measurement category according to IEC 61010-1

The product has the following test sockets:

Connector	Pin	Function
S- 	1	Negative S socket
S+ 	2	Positive S socket
CC1 	3	CC1 socket
CC2 	4	CC2 socket
DC - 	5	Negative DC socket
DC + 	6	Positive DC socket
PE 	7	PE socket
A- 	8	Negative A socket
A+ 	9	Positive A socket

Wiring diagram

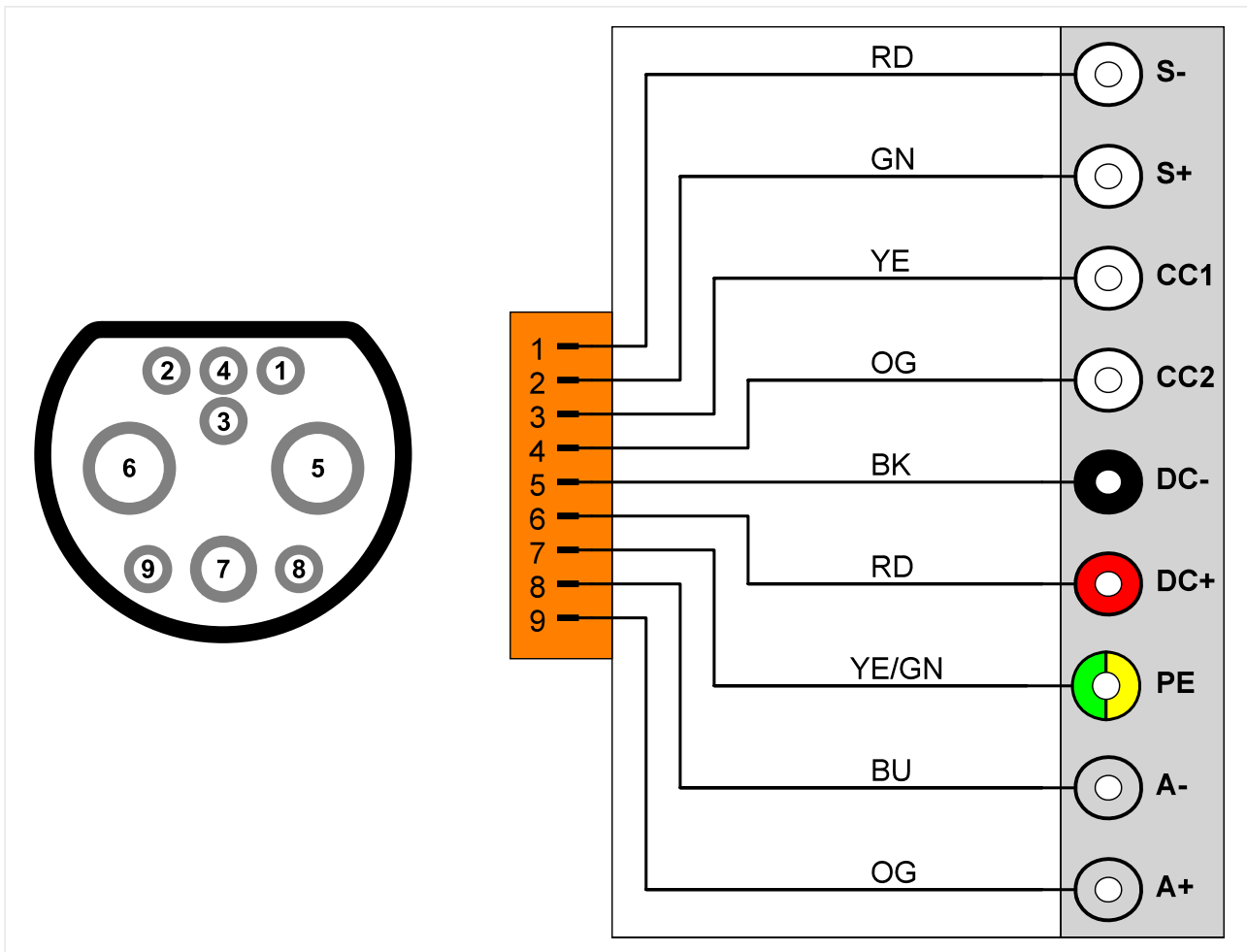

Technical data

Rated data	Values
Manufacturer number	22101589
Maximum rated voltage	DC 1000 V
Maximum rated current	1 mA
Protection class	II / double insulated
Weight	~ 550 g
Dimensions L/H/W	~ 190 mm/95 mm/110 mm

Ambient conditions	Operation	Storage	Transportation
Temperature	0 °C to 50 °C	-20 °C to 60 °C	-20 °C to 60 °C
Humidity	Max. 85 %	Max. 85 %	Max. 85 %
	Condensation not permitted. Maximum permissible relative humidity: 60 % in environments with corrosive gas/air.		

Startup

This chapter provides information about the following activities:

- Startup
- Cleaning
- Disposal
- Maintenance



WARNING

Danger of fatal electric shock!

The electrical voltage in high-voltage systems is lethal and can cause death by electric shock!

- Use the product only for the applications intended by the vehicle manufacturer!

1. Observe the safety instructions.

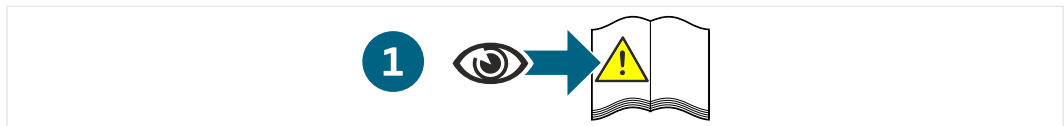

2. Insert the plug into the vehicle's charging socket.
3. Connect the high-voltage measurement module to the high-voltage measurement adapter according to the guided fault finding.

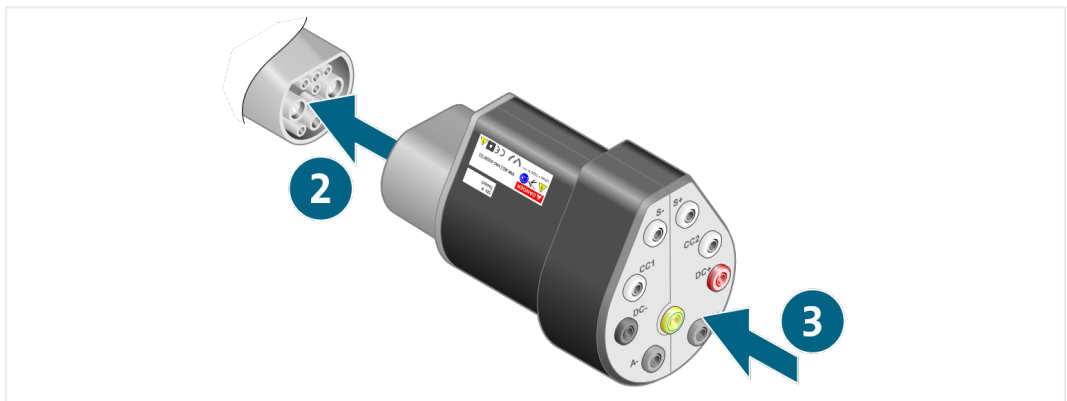

- ✓ You can now perform measurements in accordance with the guided fault finding.

Cleaning



DANGER

Danger of fatal electric shock!

The electrical voltage in high-voltage systems is lethal and will cause death by electric shock!

- Disconnect the product from all power sources before cleaning the product!

Observe the safety instructions!

Use only a dry cloth to clean the product.

Disposal

Observe the safety instructions!

Always dispose of the product in accordance with all local disposal regulations.

Maintenance

Observe the safety instructions!

National and local requirements for regular testing must be observed!

Test the product for proper function at intervals of no more than 24 months.

Contact the manufacturer to have a professional function test performed.

Warranty

CAR-connect GmbH grants a warranty period of 24 months from the date of purchase. The warranty is valid for demonstrable defects in functional material and workmanship.

Further information on the warranty conditions can be found in the terms and conditions on the manufacturer's website.

Customer service

Always include the serial number with any product queries. This number is found on the product.

CAR-connect GmbH
Am Egelingsberg 8
38542 Leiferde, Germany

Phone: +49 (0) 5373 – 92197-0

Fax: +49 (0) 5373 – 92197-88

service@car-connect.cc

www.car-connect.cc

Volkswagen Aktiengesellschaft
K-GVO-LW
Group After Sales – Group Service
Literature and Systems
Repair Shop Equipment
PO box 011/4915
38442 Wolfsburg, Germany

For internal use only
Subject to technical changes
Edition 08 / 2020